



GF1900 SULFURYL FLUORIDE MONITOR

Proprietary and Confidential: This document is the sole property of Interscan Corp. The information contained in this document is confidential and is not to be used, reproduced, or discussed without prior written consent by Interscan Corp.

THIS PAGE INTENTIONALLY LEFT BLANK

Doc 120-00007	Sulfuryl Fluoride Monitor – GF1900	
Revision:D	Proprietary and Confidential	Page 2 of 20

TABLE OF CONTENTS

INTRODUCTION.....	4
SYMBOL KEY	4
PICTURE OF GF1900	5
CASE LAYOUT.....	6-7
CAUTIONS.....	8
OPERATION.....	9
CALIBRATION.....	10
MAINTENANCE.....	11
TROUBLE SHOOTING.....	12-13
ACCESSORIES.....	14-15
WARRANTY.....	16
DIAGRAMS, SCHEMATICS, AND PARTS.....	17-19
SCHEMATIC.....	17
WIRING DIAGRAM.....	18
BATTERY PACK WIRING.....	19
CONSUMABLE PARTS.....	19
RETURN AUTHORIZATION.....	20

INTRODUCTION



The Interscan GF1900 Sulfuryl Fluoride gas fumigant analyzer is expressly designed for use as a clearance monitoring device to determine safe reoccupation of a structure after aeration only. Use of this device for any purposes other than use as a clearance device will invalidate the warranty, and is not in accordance with manufacturer's suggested use or the intended use of the device.

The furnace is a key and essential component of the GF1900. Due to extreme heat (900 degrees C) the furnace has a limited life. **Mean Time Before Failure (MTBF)** is one thousand (1000) hours. This is the average lifetime of accumulated runtime hours before the furnace will fail due to the extreme operating heat.

Note: The furnace life is further dependent on the exposure duration and level of the the Sulfuryl Fluoride (SO₂F₂) gas.



Exposure to levels in excess of 50 ppm of Sulfuryl Fluoride (SO₂F₂) gas can lead to greatly reduced life or instantaneous failure of the furnace.

The Sulfuryl Fluoride (SO₂F₂) gas is passed to the Interscan Sulfur Dioxide sensor for conversion to an electrical current in direct proportion to the gas level. This signal is then processed by the circuitry for display on the meter in engineering units of **parts per million (ppm)**.

SYMBOL KEY



- GENERAL CAUTION



- WARNING



- HEAT



- EXPLOSION

Doc 120-00007	Sulfuryl Fluoride Monitor – GF1900	
Revision:D	Proprietary and Confidential	Page 4 of 20



FIGURE 1

GF1900 INSTRUMENT IN BLUE CARRYING CASE (FIGURE 1)

FIGURE 2

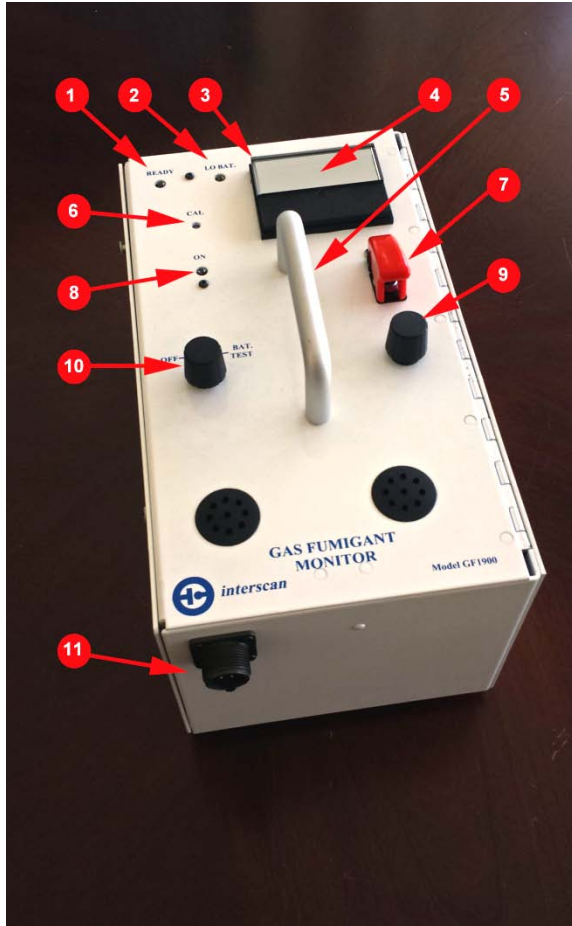

Figure 2

- 1) READY L.E.D. - Illuminates when furnace reaches proper preset operating Temperature.
Note: The "Ready" L.E.D. is not an indicator of Sensor Stabilization.
- 2) LO BAT. - illuminates when the Battery Pack or AC power supply is at 19.0 VDC.
- 3) Meter - Analog display.
- 4) Meter Dial - linear indication of the Engineering units in **Parts Per Million (PPM)**.
- 5) Carrying Handle
- 6) CAL. - Potentiometer set screw to adjust meter to display correct PPM level when exposed to calibration gas of a certified value.
- 7) Furnace Off - Lifting cover and flipping switch up turns furnace off during prolonged periods of stabilization. This helps to prolong furnace life. Normal use is with cover down.
- 8) ON L.E.D. - illuminates when power is turned on at Function Switch.
- 9) Zero - sets the Analog Meter to read zero at beginning of monitoring to compensate for sensor background current.

- 10) Function Switch - Selects operation and meter display:
ON - monitor is powered and the meter displays ppm level,
BAT TEST - analyzer is powered and meter displays battery pack level.
Note: Meter level must be at or above LO BAT mark for proper operation.
- 11) Power Connector – input connector for Battery Pack or AC Power Supply.

Doc 120-00007	Sulfuryl Fluoride Monitor – GF1900	
Revision:D	Proprietary and Confidential	Page 6 of 20

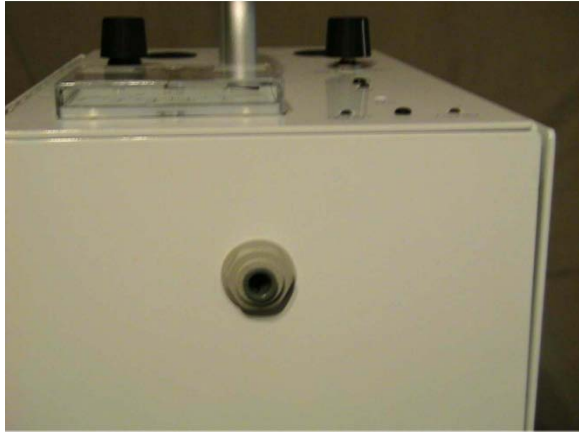

FIGURE 3

Gas sample inlet PORT (figure 3). Tubing is pushed into port until seated and then gently pulling back. The pulling back action is performed to properly seal the connection. Teflon tubing $\frac{1}{4}$ O.D. x $\frac{1}{8}$ I.D or 0.63500cm OD x 0.31750 cm ID. is recommended for use. Length should not exceed twelve (12) inches (30.480 cm) when used with factory calibration. Lengths of twelve (12) inches (30.480 cm) to forty eight (48) inches (121.92 cm) can be used only if calibrated with chosen length attached during process.

NOTE: Longer lengths than twelve (12) inches (30.480 cm) can increase response time.

CAUTIONS

Figure 4

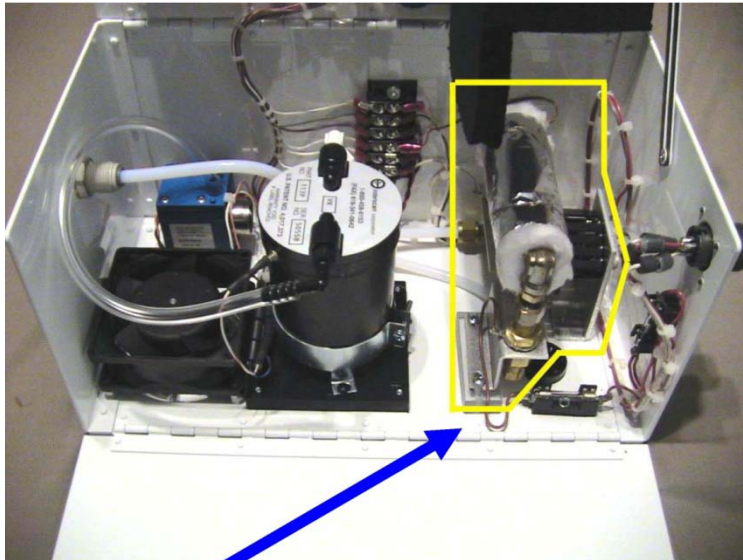

- 1)  Items inside yellow boundary can cause injury. **Do not** attempt to service until instrument has cooled for one (1) hour. (Figure 4)

- 2)  **DO NOT** attempt to use in areas where gasoline, sulfur compounds, or highly flammable vapors are present. The presence of any of these could produce an **EXPLOSION**.

- 3) Areas which operate mobile phones, CB's, etc., may cause electronic interference. This is evidenced by random or erratic meter deflection.

OPERATION

- 1) Turn the **FUNCTION SWITCH** knob to the **OFF** position and connect the AC power supply (PN# 040-00079) (110VAC) or (PN# 040-00080) (220VAC) or battery pack (BP24V) . Tighten the connector completely.



NOTE: Turn only the knurled ring to tighten. Tightening the connection by turning any other portion of cable can result in a short, fire, or explosion.

- 2) Turn the **FUNCTION SWITCH** to **ON** and wait for the READY indicator to light.

- 3) After the READY indicator is ON, set the meter to ZERO with the **ZERO** knob.

NOTE: New or replacement sensors may require approximately 24 hours to stabilize prior to zeroing. During this period you can lift the Furnace Off cover to up position and lift the switch up toward (figure 5) the Meter to prevent the furnace from running. This action helps to extend furnace life. Return the Furnace off cover to the down position when the monitor is stable. For best results (to prevent zero drift) the first time the monitor is used during the day, set the meter to 20 after the READY light is ON. If the meter is moving up or down, wait until it stops. Then adjust the meter to ZERO.



Furnace Switch
Open/off



Furnace Switch
Open/on



Furnace Switch
Closed/on

Figure 5

- 4) The unit is now ready to use.
- 5) When using the battery pack, the **LO BAT** indicator will light when there is approximately 10 minutes operating time left. After the light is ON, turn the control knob to **BAT TEST** to see if the meter is ON, or to the left of the BAT line. If the meter is to the right of the line, turn back to ON for continued gas readings. Check the battery condition every few minutes. When the meter shows **LO BAT**, turn the control knob to OFF.
- 6) Recharge batteries overnight. Approximately nine (9) to ten (10) hours.
- 7) Approximately 70 minutes operating time is available with a fully charged battery pack.

NOTE: Disregard a LO BAT indication when using an AC power source.

Doc 120-00007	Sulfuryl Fluoride Monitor – GF1900	
Revision:D	Proprietary and Confidential	Page 9 of 20

CALIBRATION

Note: Should be performed every 3 months or more frequent. Some companies require monthly calibration.

The instrument is calibrated by introducing, a known concentration of Sulfuryl Fluoride gas (5 ppm), and adjusting the SPAN control to correspond to the known analysis of the gas.

NOTE: New or replacement sensors may require approximately 24 hours to stabilize prior to zeroing.

With the unit turned on and sufficiently warmed up with the READY light illuminated, zero the analyzer with the ZERO control. Fill a sample bag with Sulfuryl Fluoride standard, and connect it to the inlet, allowing the gas to flow for at least 3 minutes. DO NOT ATTEMPT TO INTRODUCE THE SO₂F₂ STANDARD DIRECTLY FROM A PRESSURIZED SOURCE. A SAMPLE BAG MUST BE USED. Do not introduce concentrations higher than 50 ppm.

The CAL control is used to set the meter to a value corresponding to the span gas concentration. Disconnect the sample bag. Allow to stabilize for 3 minutes. Repeat procedure two additional times. The readings should be within ± 2 divisions of the average of your three readings.

Doc 120-00007	Sulfuryl Fluoride Monitor – GF1900	
Revision:D	Proprietary and Confidential	Page 10 of 20

MAINTENANCE

Furnace Replacement

Be sure power is disconnected and the analyzer is allowed to cool.



Do not attempt to service until cooled for a minimum of one (1) hour.

Remove the thermocouple leads at terminals 3 and 6 of the terminal block (figure 6). For easy access, loosen the sensor clamp screw and lift the sensor out, placing it on the fan. It should not be necessary to remove any tubing.

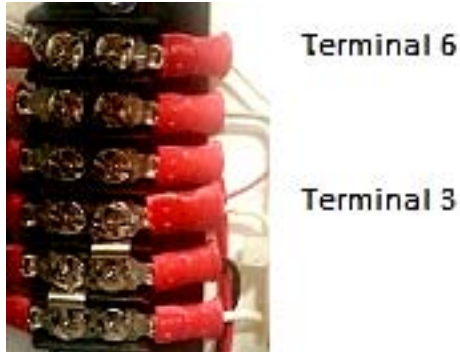

Figure 6

Minimize twisting by gripping supports before loosening the coupling nuts. Before installing the replacement furnace, loosen the screws on the slotted support bracket. Drill and tap two new 6/32 holes (0.47625 cm) ¼ inch (0.63500 cm) from old toward door side if only two holes are present in the clear block. This allows for newer furnaces which may be longer or shorter than original equipment. **First test fit new furnace. Move slotted mounting bracket screws to a position that does not distort the furnace fittings. Failure to check this may damage furnace. Do not twist furnace fittings as they are a press fit and can be damaged.**

Position the furnace and hand-tighten the coupling nuts. Secure the bracket and snugly tighten the coupling nuts while maintaining the position of the fitting with a second wrench. Note: Excessive force will result in furnace damage. Connect thermocouple wires and replace the sensor. Close the top to position the insulator so it does not lie against the furnace.

Doc 120-00007	Sulfuryl Fluoride Monitor – GF1900	
Revision:D	Proprietary and Confidential	Page 11 of 20

TROUBLE SHOOTING

READY light does not illuminate.

Check that the POWER L.E.D. is illuminated. If it is not:

- 1) Check the main fuse. 2) Check that the rear connector is tight. 3) Check the power source for a nominal 24V. 4) Check that the circuit board connector is tight.

If POWER L.E.D. is illuminated:

- 1) Carefully check if the furnace is cold.
- 2) If furnace is cold, check for an open 4A fuse.
- 3) If fuse is good, disconnect the power source and connect an ohmmeter across the furnace support brackets. The reading should be less than 5 ohms.

If the furnace is good, reconnect the power source and turn the analyzer on.

With a DVM, check the voltage at the Q4 regulator output. It should read 16.45 VDC or greater to allow proper warm up time of 6 to 9 minutes. Adjustments are performed by turning the potentiometer screw of R12.

If regulator output is normal, check for the same voltage 16.45VDC at Q5 base and for 24V at the collector, if battery power is being used the voltage can be 19V to 27.6V. Normal readings here indicate a failed Q5, or discontinuity between the furnace and emitter, or furnace and ground.

To check Q4:

- 1) If Q4 output is close to zero and feels hot, C7 may be shorted.
- 2) If Q4 is cool, check for 24V at the input.
- 3) Check the voltage at the "R" terminal. If it is 1V or less and the output is around 2V, Q1 has failed or is being activated.

Furnace is hot, READY light is not on.

Thermocouple may be defective. Check across leads for mV reading. The reading should be greater than 20 mV after 5 minutes. Reverse thermocouple leads if the reading is negative.

If thermocouple is okay, R27 may be set incorrectly. With the thermocouple reading approximately 35 mV, adjust R27 to get a READY indication.

Doc 120-00007	Sulfuryl Fluoride Monitor – GF1900	
Revision:D	Proprietary and Confidential	Page 12 of 20

TROUBLE SHOOTING Con't.

No response to SO₂F₂. Furnace hot.

Make sure that the hole in the Sensor inlet fitting is not blocked.

Check that banana plug is connected to the sensor and the clamp is tight.

Check for 550 mV (± 20 mV) on sensor clamp or blue wire to the sensor.

Check that the meter responds to ZERO control.

Connect a rotameter to the inlet and open the valve completely.

Check for approximately 50-100 cc/min flow.

Meter off scale. No response to ZERO control.

Disconnect sensor banana plug and check for ZERO control.

Check output of Q2 for 4.5 to 5.5V.

Check output of U3 for a negative reading 93% or greater of the value at Q2.

Sensor clamp or voltage at blue wire to sensor not at 550 mV (± 20 mV).

Check reference voltage at CR1. This should read between 1.21 and 1.23 V.

Meter drifts when trying to Zero.

Sensor may not be stable due to being powered down for a long period. Leave FUNCTION SWITCH on, lift "Furnace Off" cover up and flip the switch up toward Meter. Check the meter for drift and adjust as necessary until stable. Position "Furnace Off" cover down when stability has been achieved.

Doc 120-00007	Sulfuryl Fluoride Monitor – GF1900	
Revision:D	Proprietary and Confidential	Page 13 of 20

ACCESSORIES

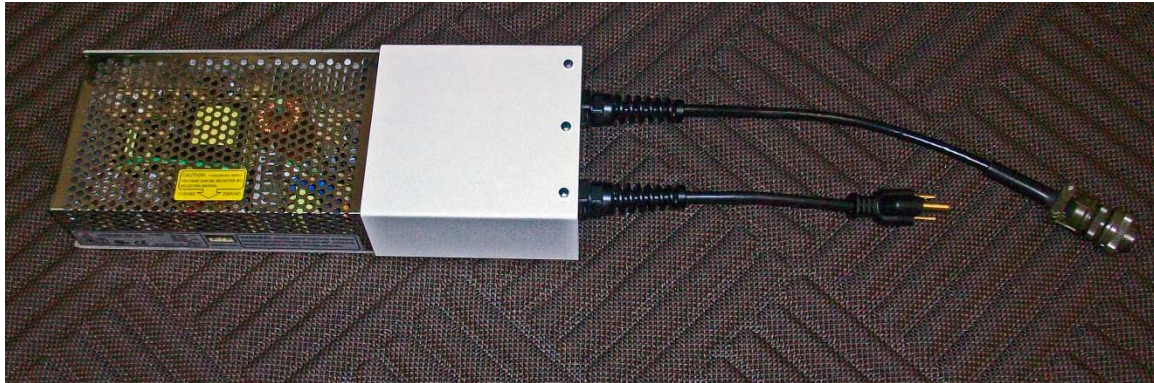

Figure 7

Figure 7: AC Power Supply - P/N 040-00079 (110VAC) , P/N 040-00080 (220VAC)

ACCESSORIES Con't.



Figure 8

Figure 8: 24 VDC Battery Pack - P/N BP24V



Figure 9

Figure 9: Battery Charger - P/N 040-00077

WARRANTY

INTERSCAN CORPORATION warrants the GF1900 gas fumigant analyzer of its manufacture (*furnaces, sensors, batteries, fuses lamps, tubing, fittings, filters and scrubbers EXCEPTED*) to be free from defects in material and workmanship for a period of one year from date of shipment.

INTERSCAN CORPORATION warrants furnaces for six (6) months from date of shipment to be free from defects in material and workmanship. No warranty is expressed or implied as to the functional life of the furnace.

INTERSCAN CORPORATION warrants sensors of its manufacture to be free from defects in material and workmanship for a period of six (6) months from date of shipment.

INTERSCAN CORPORATION's sole obligation under this warranty is limited to repairing or replacing, at its option, any item covered under this warranty, when such item is returned intact, prepaid to the factory (or designated service center).

This warranty **does not** apply to any of our products which have been repaired or altered by unauthorized persons, or which have been subject to misuse, negligence, or accident, incorrect wiring by others, installation or use not in accordance with instructions furnished by the manufacturer, or which have had the serial numbers altered, effaced, or removed. The sensors are factory sealed and **must not be opened or modified** in the field for the warranty to remain in effect. This warranty is in lieu of all other warranties, whether expressed or implied.

Additionally, in a custom system, warranty on any component shall not exceed the manufacturer's warranty given to INTERSCAN CORPORATION.

Doc 120-00007	Sulfuryl Fluoride Monitor – GF1900	
Revision:D	Proprietary and Confidential	Page 16 of 20

DIAGRAMS, SCHEMATICS & PARTS

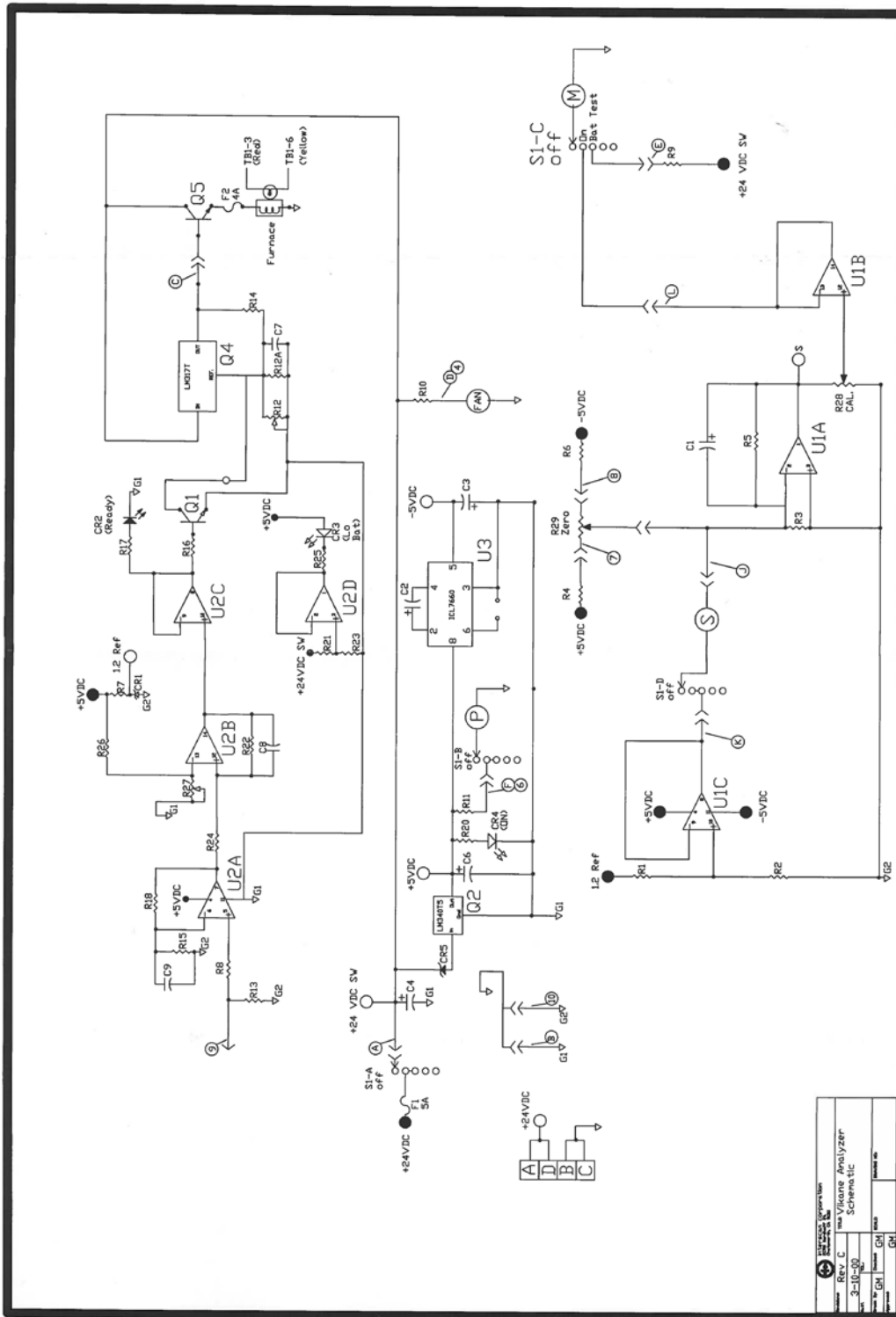

DIAGRAMS, SCHEMATICS & PARTS, Con't.

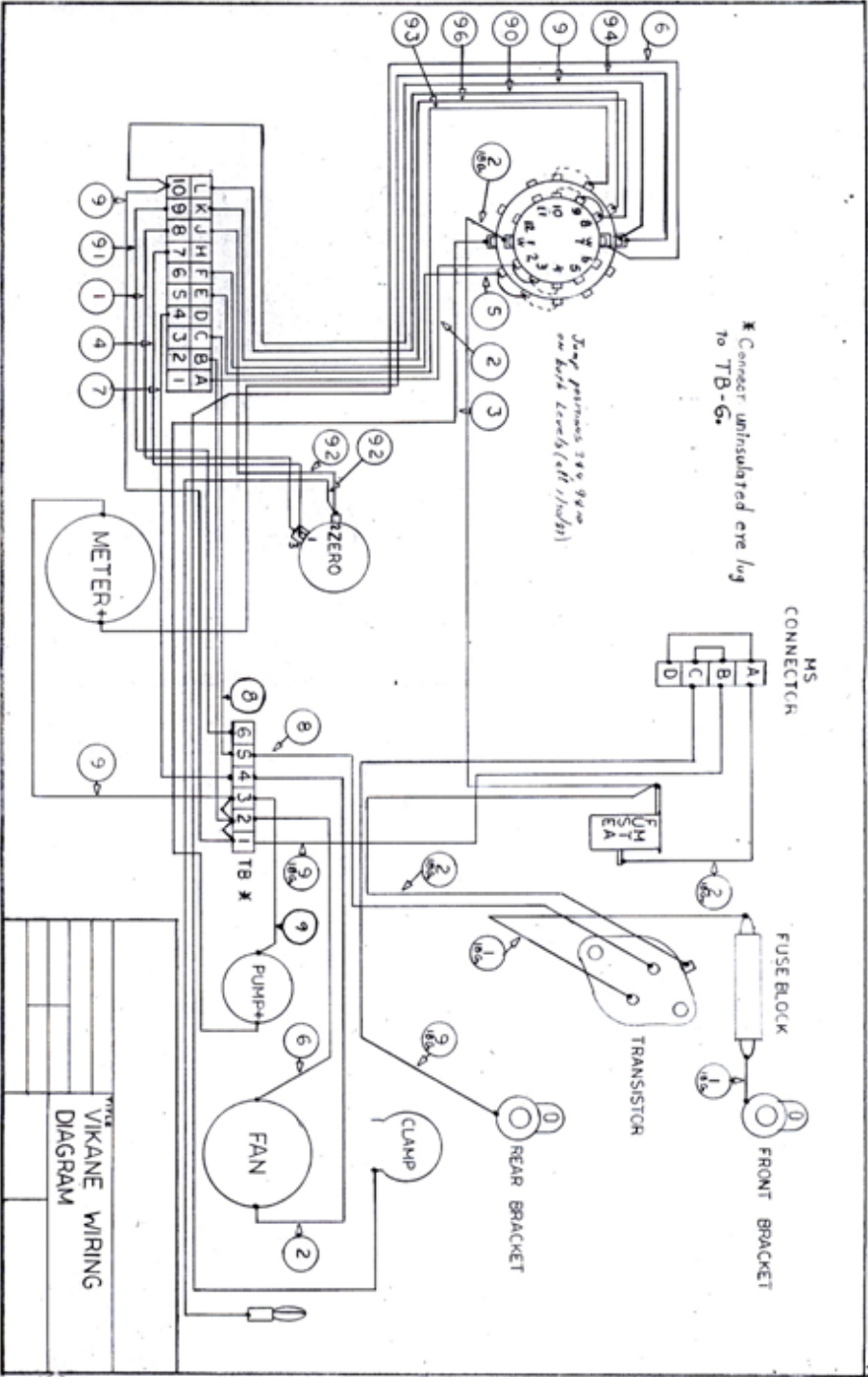

DIAGRAMS, SCHEMATICS & PARTS, Con't.

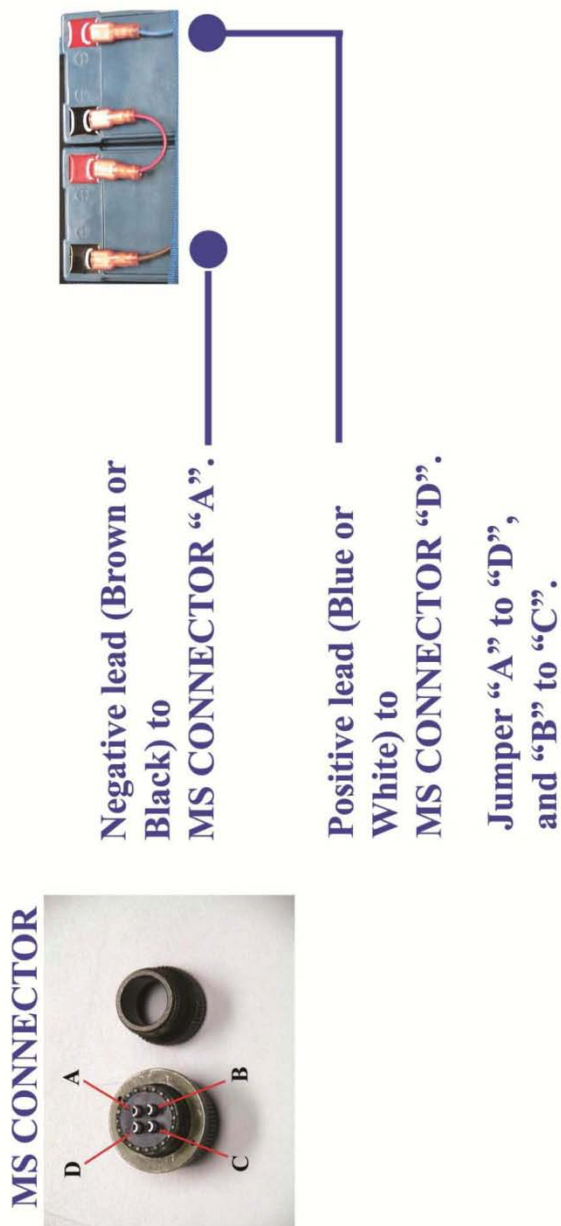

BATTERY PACK WIRING

Parts

- 113-P Sulfuryl Fluoride (So2F2) Sensor
- 050-00035 Furnace, Sulfuryl Fluoride

Doc 120-00007	Sulfuryl Fluoride Monitor – GF1900	
Revision:D	Proprietary and Confidential	Page 19 of 20

RETURN AUTHORIZATION

All returns for repair require a RETURN AUTHORIZATION NUMBER issued by the INTERSCAN Service Department upon request.

This is done primarily to cause the user to contact the factory directly, as a high percentage of service problems can be resolved over the telephone, avoiding the need for returning the instrument or part.

The user is advised to consult the "TROUBLESHOOTING" section of the manual prior to contacting the factory. This will avoid erroneous conclusions by the user as to the problem before contacting the factory.

Should return of the instrument or part be advised by the Service Department, the "RETURN AUTHORIZATION NUMBER" will expedite prompt return of the repaired unit.

Below you will find the link to the online RMA request form:

<http://www.gasdetection.com/contact-interscan/rma-request/>

For service information please contact:

INTERSCAN CORPORATION
Service Department
(818) 882-2331
(800) 458-6153 (USA & CANADA)
FAX: (818) 341-0642

Doc 120-00007	Sulfuryl Fluoride Monitor – GF1900	
Revision:D	Proprietary and Confidential	Page 20 of 20